

LM4811 Boomer® Audio Power Amplifier Series

Dual 105mW Headphone Amplifier with Digital Volume Control and Shutdown Mode

General Description

The LM4811 is a dual audio power amplifier capable of delivering 105mW per channel of continuous average power into a 16Ω load with 0.1% (THD+N) from a 5V power supply.

Boomer audio power amplifiers were designed specifically to provide high quality output power with a minimal amount of external components. Since the LM4811 does not require bootstrap capacitors or snubber networks, it is optimally suited for low-power portable systems.

The LM4811 features a digital volume control that sets the amplifier's gain from +12dB to -33dB in 16 discrete steps using a two-wire interface.

The unity-gain stable LM4811 also features an externally controlled, active-high, micropower consumption shutdown mode. It also has an internal thermal shutdown protection mechanism.

Key Specifications

- THD+N at 1kHz, 105mW continuous average output power into 16Ω 0.1% (typ)
- THD+N at 1kHz, 70mW continuous average power into 32Ω 0.1% (typ)
- Shutdown Current 0.3μA (typ)

Features

- Digital volume control range from +12dB to -33dB
- LD and MSOP surface mount packaging
- "Click and Pop" suppression circuitry
- No bootstrap capacitors required
- Low shutdown current

Applications

- Cellular Phones
- MP3, CD, DVD players
- PDA's
- Portable electronics

Connection Diagrams

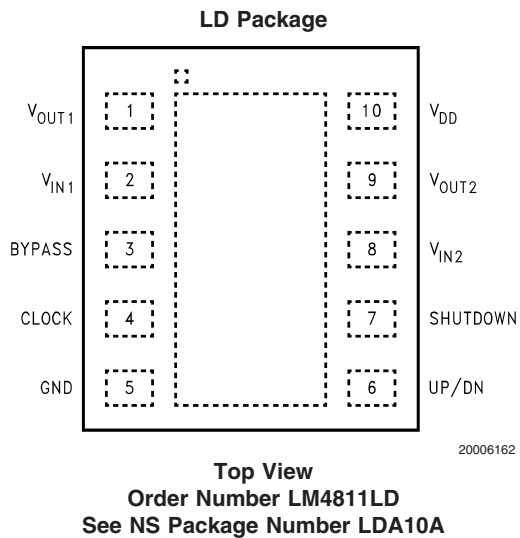
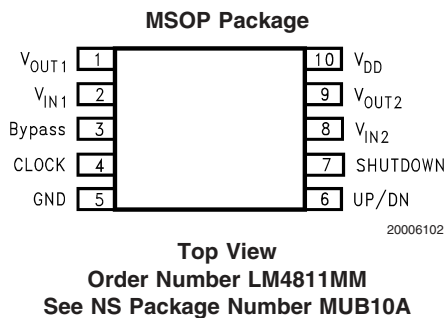

Boomer® is a registered trademark of National Semiconductor Corporation.

Typical Application

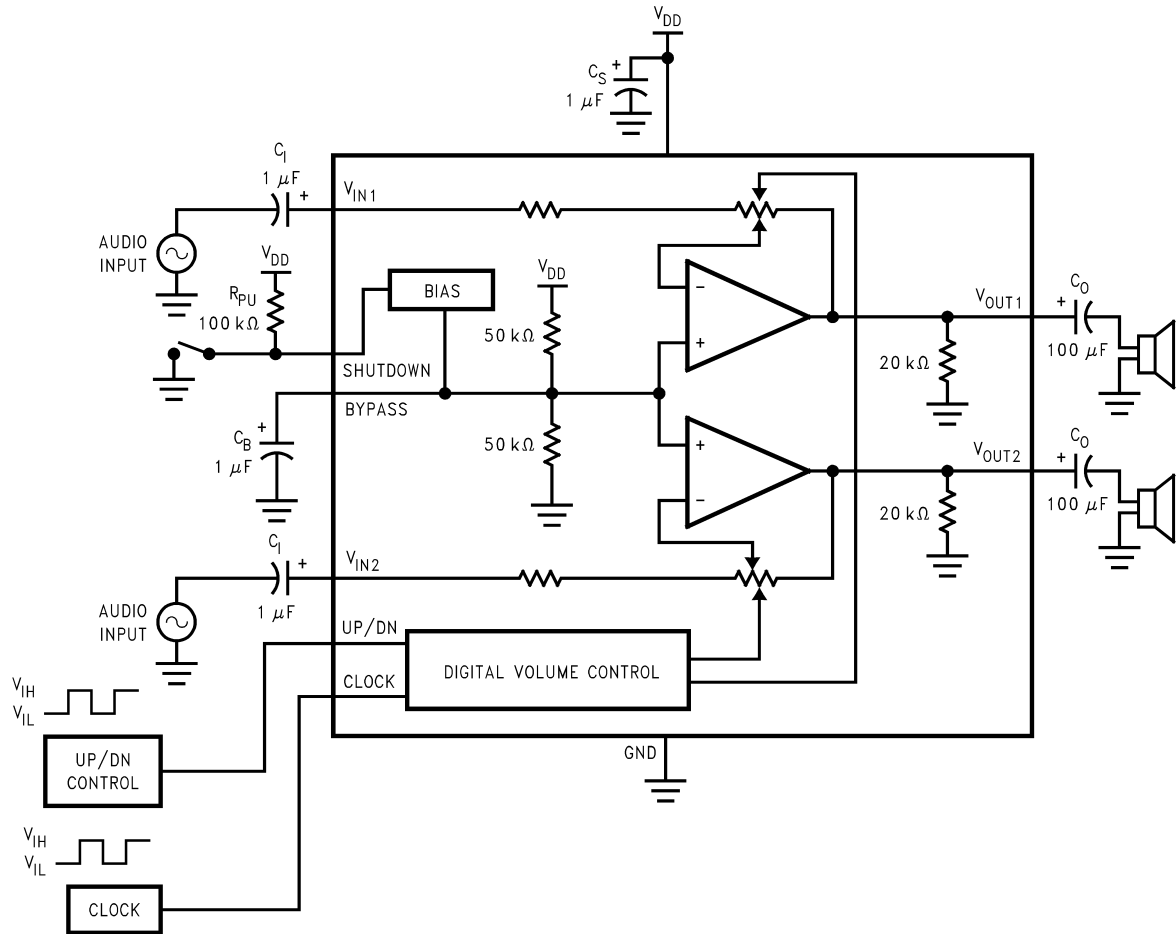

*Refer to the **Application Information** Section for information concerning proper selection of the input and output coupling capacitors.

20006101

FIGURE 1. Typical Audio Amplifier Application Circuit

Absolute Maximum Ratings (Note 1)

If Military/Aerospace specified devices are required, please contact the National Semiconductor Sales Office/Distributors for availability and specifications.

Supply Voltage	6.0V
Storage Temperature	-65°C to +150°C
ESD Susceptibility (Note 3)	2.5kV
ESD Susceptibility Machine model (Note 6)	200V
Junction Temperature (T _J)	150°C
Soldering Information	
Small Outline Package	
Vapor Phase (60 sec.)	215°C

Infrared (15 sec.)	220°C
Thermal Resistance	
θ _{JA} MUB10A	194°C/W
θ _{JC} MUB10A	52°C/W
θ _{JA} LDA10A (Note 7)	63°C/W
θ _{JC} LDA10A (Note 7)	12°C/W

Operating Ratings

Temperature Range	
T _{MIN} ≤ T _A ≤ T _{MAX}	-40°C ≤ T _A ≤ 85°C
Supply Voltage	2.0V ≤ V _{CC} ≤ 5.5V

Electrical Characteristics (Notes 1, 8)

The following specifications apply for V_{DD} = 5V unless otherwise specified, limits apply to T_A = 25°C.

Symbol	Parameter	Conditions	LM4811		Units (Limits)
			Typical (Note 4)	Limit (Note 5)	
V _{DD}	Supply Voltage			2.0	V (min)
				5.5	V (max)
I _{DD}	Supply Current	V _{IN} = 0V, I _O = 0A	1.3	3.0	mA
I _{SD}	Shutdown Current	V _{IN} = 0V	0.3		μA
V _{OS}	Output Offset Voltage	V _{IN} = 0V	4.0	50	mV
P _O	Output Power	0.1% THD+N; f = 1kHz			
		R _L = 16Ω	105		mW
		R _L = 32Ω	70		mW
THD+N	Total Harmonic Distortion	P _O = 50mW, R _L = 32Ω f = 20Hz to 20kHz	0.3		%
Crosstalk	Channel Separation	R _L = 32Ω; f = 1kHz; P _O = 70mW	100		dB
PSRR	Power Supply Rejection Ratio	C _B = 1.0μF, V _{RIPPLE} = 100mV _{PP} f = 217Hz	60		dB
V _{IH}	(CLOCK, UP/DN, SHUTDOWN) Input Voltage High			1.4	V (min)
V _{IL}	(CLOCK, UP/DN, SHUTDOWN) Input Voltage Low			0.4	V (max)
	Digital Volume Range	Input referred minimum gain	-33		dB
		Input referred maximum gain	+12		dB
	Digital Volume Stepsize	All 16 discrete steps	3.0		dB
	Stepsize Error	All 16 discrete steps	±0.3		dB
	Channel-to-Channel Volume Tracking Error	All gain settings from -33dB to +12dB	0.15		dB
	Shutdown Attenuation	Shutdown mode active	-100		dB

Electrical Characteristics (Notes 1, 8)

The following specifications apply for $V_{DD} = 3.3V$ unless otherwise specified, limits apply to $T_A = 25^\circ C$.

Symbol	Parameter	Conditions	LM4811		Units (Limits)
			Typical (Note 4)	Limit (Note 5)	
I_{DD}	Supply Current	$V_{IN} = 0V, I_O = 0A$	1.1		mA
I_{SD}	Shutdown Current	$V_{IN} = 0V$	0.3		μA
V_{OS}	Output Offset Voltage	$V_{IN} = 0V$	4.0		mV
P_o	Output Power	0.1% THD+N; $f = 1kHz$			
		$R_L = 16\Omega$	40		mW
		$R_L = 32\Omega$	28		mW
THD+N	Total Harmonic Distortion	$P_O = 25mW, R_L = 32\Omega$ $f = 20Hz$ to $20kHz$	0.5		%
PSRR	Power Supply Rejection Ratio	$C_B = 1.0\mu F, V_{RIPPLE} = 100mV_{PP}$ $f = 217Hz$	60		dB
V_{IH}	(CLOCK, UP/DN, SHUTDOWN) Input Voltage High		1.4		V (min)
V_{IL}	(CLOCK, UP/DN, SHUTDOWN) Input Voltage Low		0.4		V (max)
	Digital Volume Range	Input referred minimum gain	-33		dB
		Input referred maximum gain	+12		dB
	Digital Volume Stepsize	All 16 discrete steps	3.0		dB
	Stepsize Error	All 16 discrete steps	± 0.3		dB
	Channel-to-Channel Volume Tracking Error	All gain settings from -33dB to +12dB	0.15		dB
	Shutdown Attenuation	Shutdown mode active	-100		dB

Electrical Characteristics (Notes 1, 8)

The following specifications apply for $V_{DD} = 2.6V$ unless otherwise specified, limits apply to $T_A = 25^\circ C$.

Symbol	Parameter	Conditions	LM4811		Units (Limits)
			Typical (Note 4)	Limit (Note 5)	
I_{DD}	Supply Current	$V_{IN} = 0V, I_O = 0A$	1.0		mA
I_{SD}	Shutdown Current	$V_{IN} = 0V$	0.3		μA
V_{OS}	Output Offset Voltage	$V_{IN} = 0V$	4.0		mV
P_o	Output Power	0.1% THD+N; $f = 1kHz$			
		$R_L = 16\Omega$	20		mW
		$R_L = 32\Omega$	16		mW
THD+N	Total Harmonic Distortion	$P_O = 15mW, R_L = 32\Omega$ $f = 20Hz$ to $20kHz$	0.6		%
PSRR	Power Supply Rejection Ratio	$C_B = 1.0\mu F, V_{RIPPLE} = 100mV_{PP}$ $f = 217Hz$	60		dB
V_{IH}	(CLOCK, UP/DN, SHUTDOWN) Input Voltage High		1.4		V (min)
V_{IL}	(CLOCK, UP/DN, SHUTDOWN) Input Voltage Low		0.4		V (max)
	Digital Volume Range	Input referred minimum gain	-33		dB
		Input referred maximum gain	+12		dB
	Digital Volume Stepsize	All 16 discrete steps	3.0		dB
	Stepsize Error	All 16 discrete steps	± 0.3		dB
	Channel-to-Channel Volume Tracking Error	All gain settings from -33dB to +12dB	0.15		dB

Electrical Characteristics (Notes 1, 8) (Continued)

The following specifications apply for $V_{DD} = 2.6V$ unless otherwise specified, limits apply to $T_A = 25^\circ C$.

Symbol	Parameter	Conditions	LM4811		Units (Limits)
			Typical (Note 4)	Limit (Note 5)	
	Shutdown Attenuation	Shutdown mode active	-75		dB

Note 1: Absolute Maximum Ratings indicate limits beyond which damage to the device may occur.

Note 2: Operating Ratings indicate conditions for which the device is functional, but do not guarantee specific performance limits. For guaranteed specifications and test conditions, see the Electrical Characteristics. The guaranteed specifications apply only for the test conditions listed. Some performance characteristics may degrade when the device is not operated under the listed test conditions.

Note 3: Human body model, 100pF discharged through a 1.5kΩ resistor.

Note 4: Typical specifications are specified at +25°C and represent the most likely parametric norm.

Note 5: Tested limits are guaranteed to National's AOQL (Average Outgoing Quality Level). Datasheet min/max specification limits are guaranteed by design, test, or statistical analysis.

Note 6: Machine Model ESD test is covered by specification EIAJ IC-121-1981. A 200pF cap is charged to the specified voltage, then discharged directly into the IC with no external series resistor (resistance of discharge path must be under 50 Ohms).

Note 7: The LDA10A package has its Exposed-DAP soldered to an exposed 2in² area of 1oz printed circuit board copper.

Note 8: All voltages are measured with respect to the ground pin, unless otherwise specified.

External Components Description

(Figure 1)

Components	Functional Description
1. C_i	This is the input coupling capacitor. It blocks the DC voltage at, and couples the input signal to, the amplifier's input terminals. C_i also creates a highpass filter with the internal input resistor, R_i , at $f_c = 1/(2\pi R_i C_i)$. The minimum value of R_i is 33kΩ. Refer to the section, Proper Selection of External Components , for an explanation of how to determine the value of C_i .
2. C_S	This is the supply bypass capacitor. It provides power supply filtering. Refer to the Application Information section for proper placement and selection of the supply bypass capacitor.
3. C_B	This is the BYPASS pin capacitor. It provides half-supply filtering. Refer to the section, Proper Selection of External Components , for information concerning proper placement and selection of C_B .
4. C_O	This is the output coupling capacitor. It blocks the DC voltage at the amplifier's output and it forms a high pass filter with R_L at $f_o = 1/(2\pi R_L C_O)$

Typical Performance Characteristics

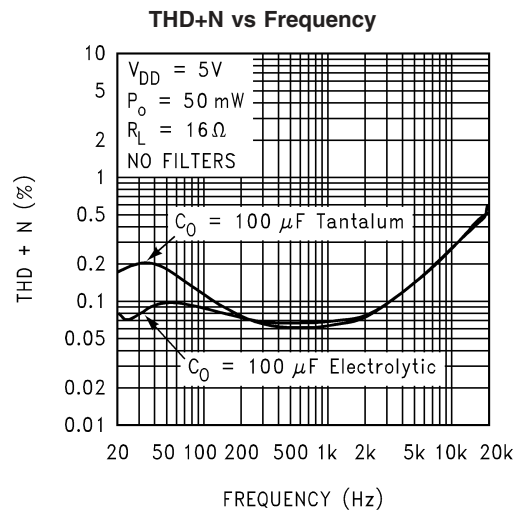
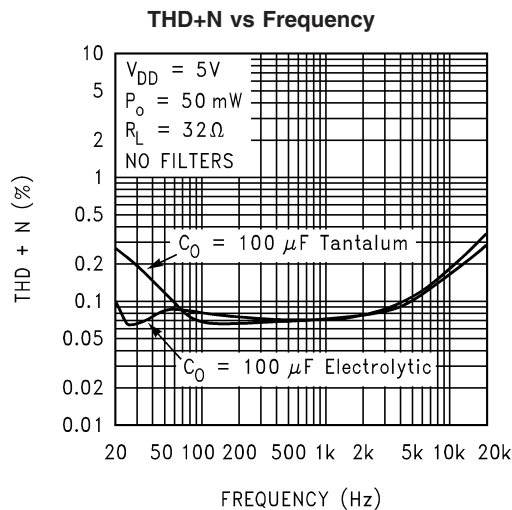

Typical Performance Characteristics (Continued)

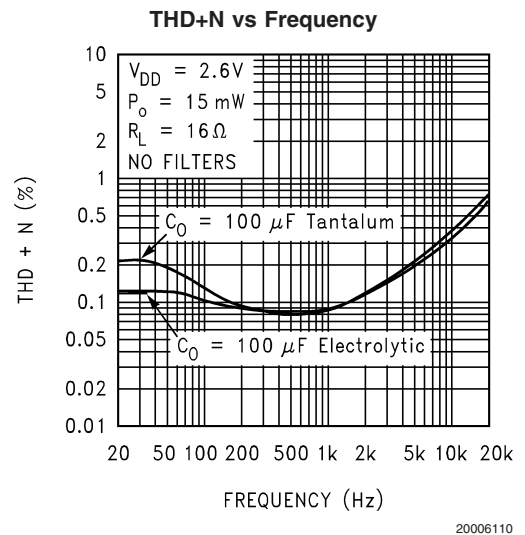
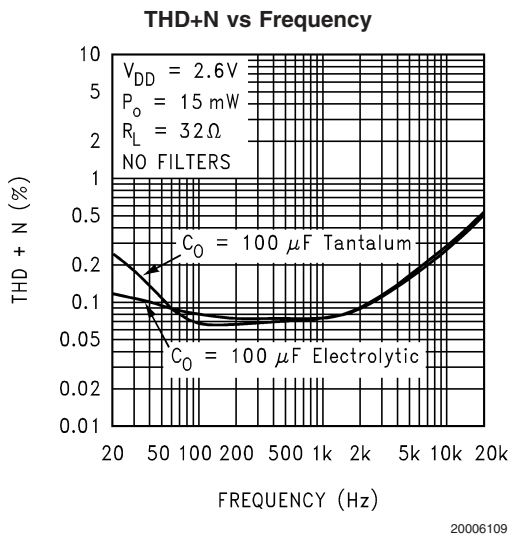
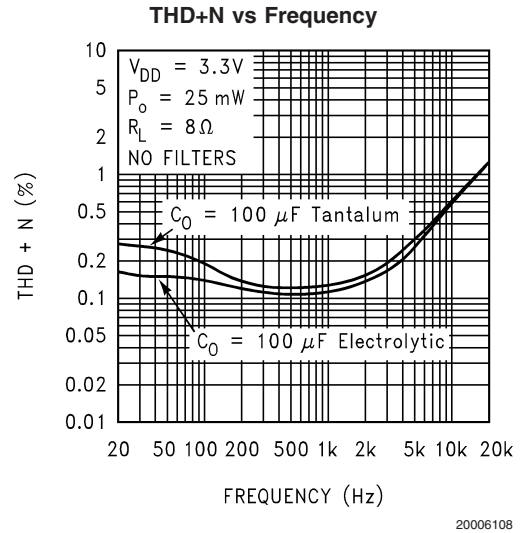
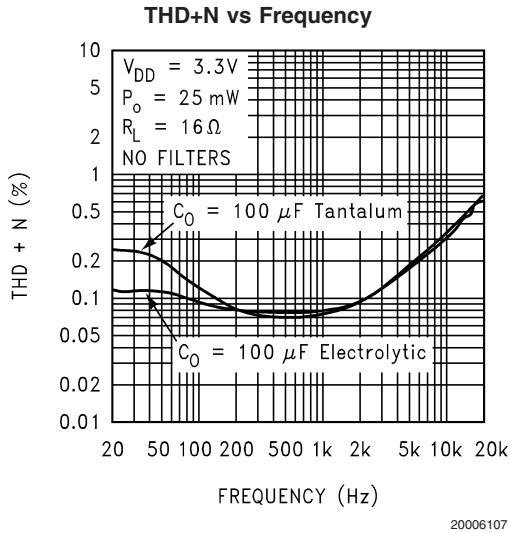
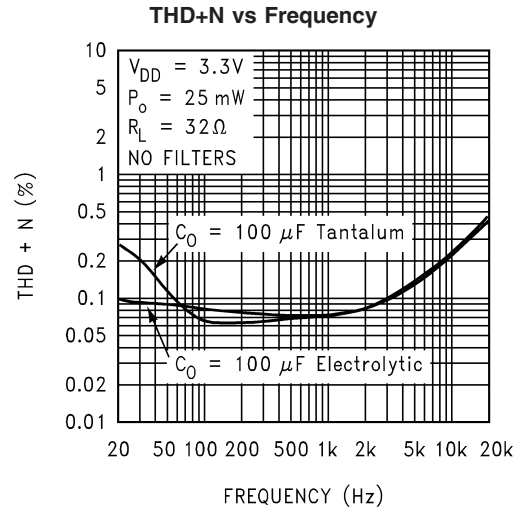
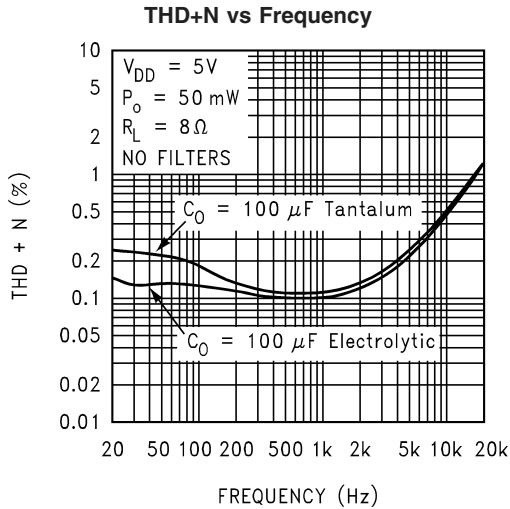

Typical Performance Characteristics (Continued)

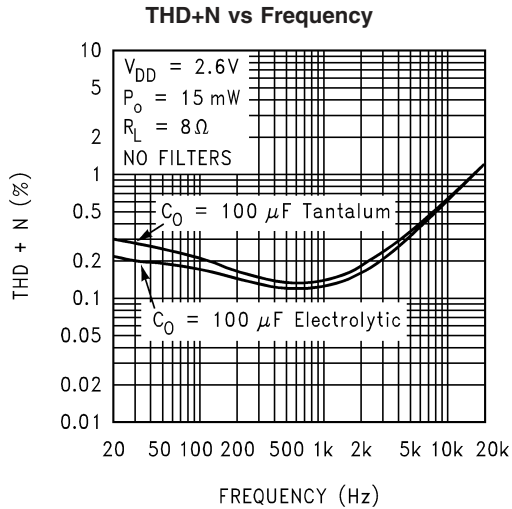

20006111

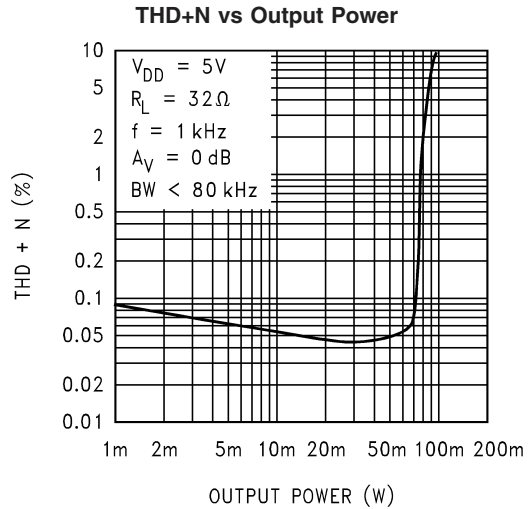

20006112

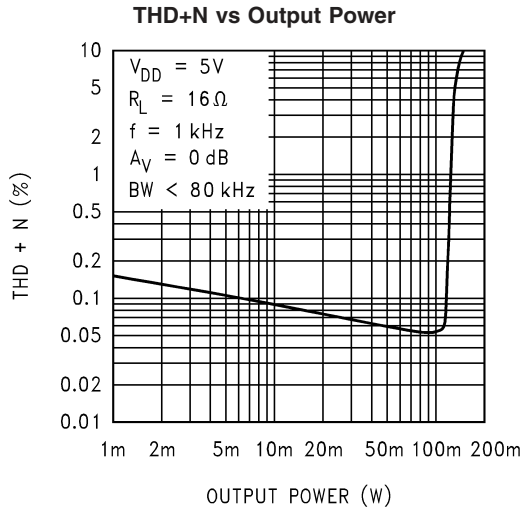

20006113

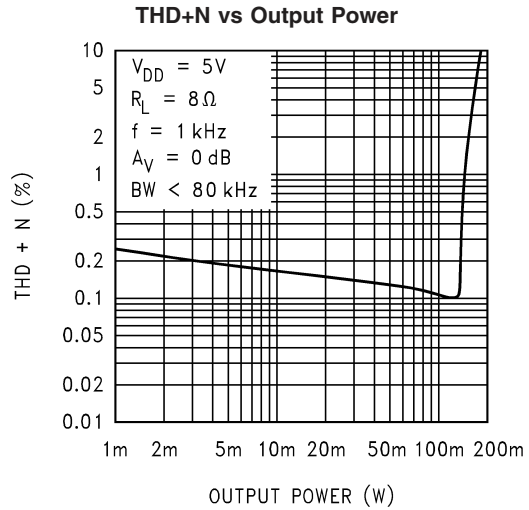

20006114

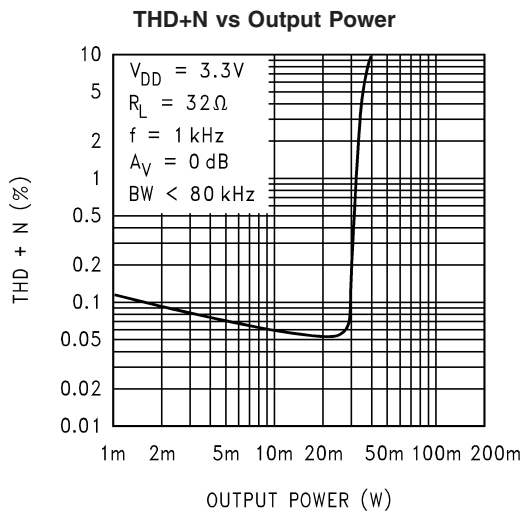

20006115

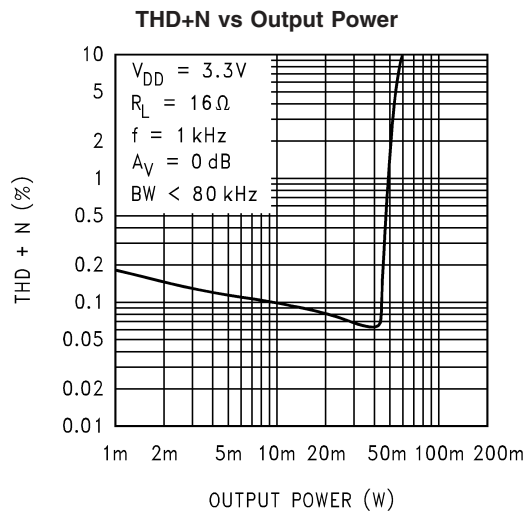

20006116

Typical Performance Characteristics (Continued)

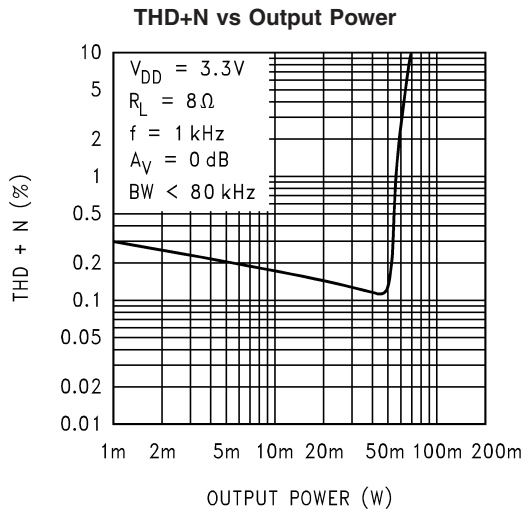

20006117

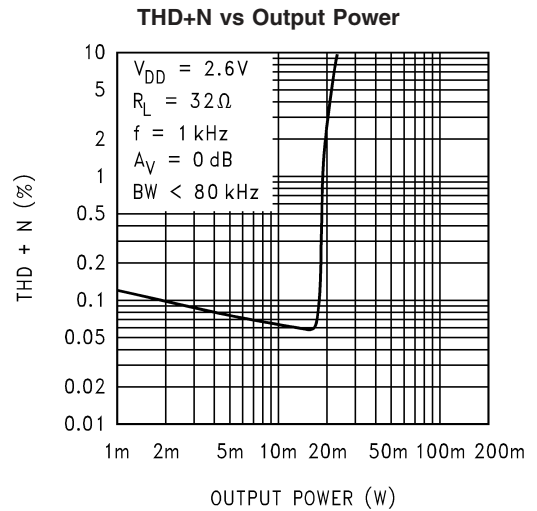

20006118

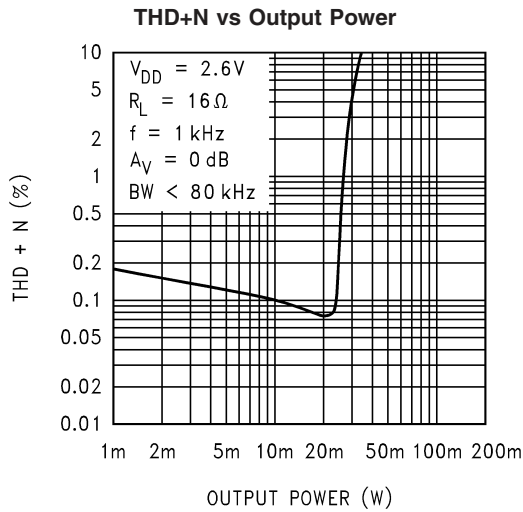

20006119

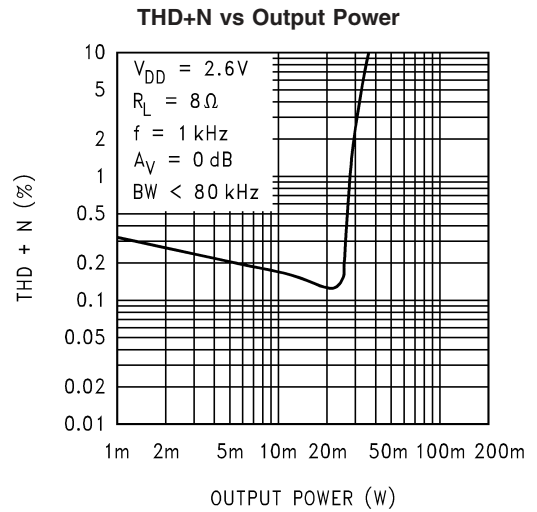

20006120

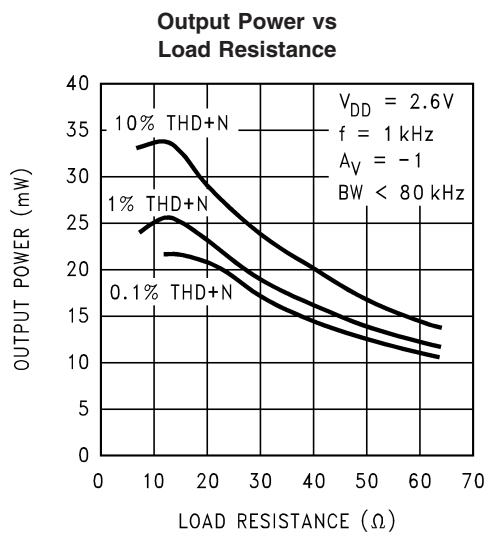

20006122

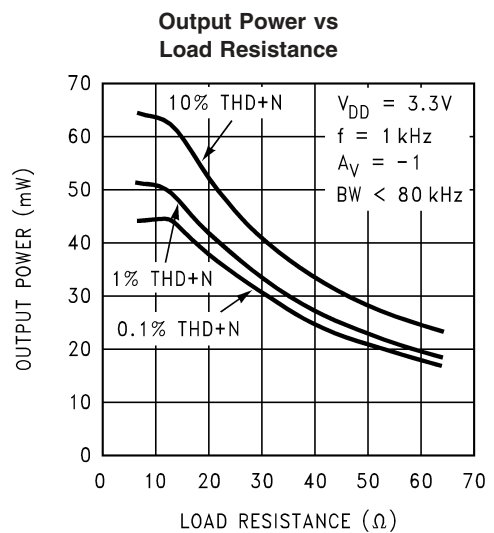

20006123

Typical Performance Characteristics (Continued)

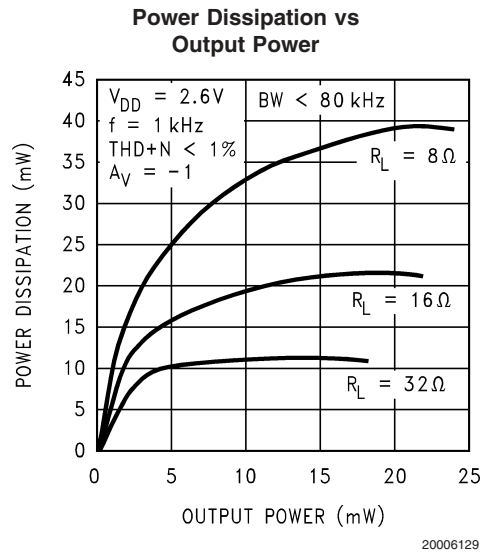
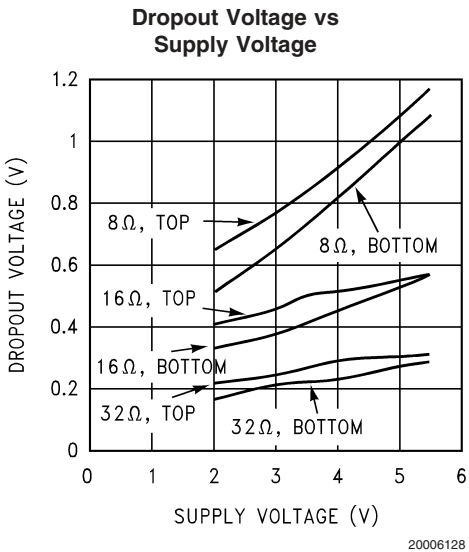
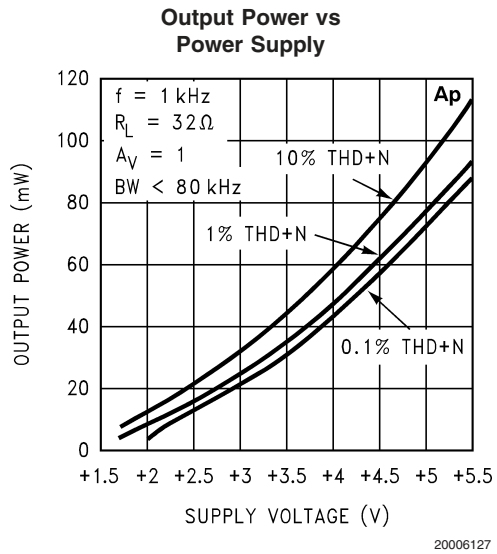
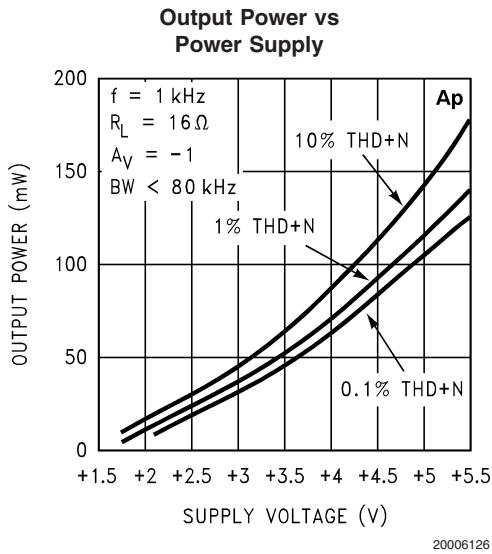
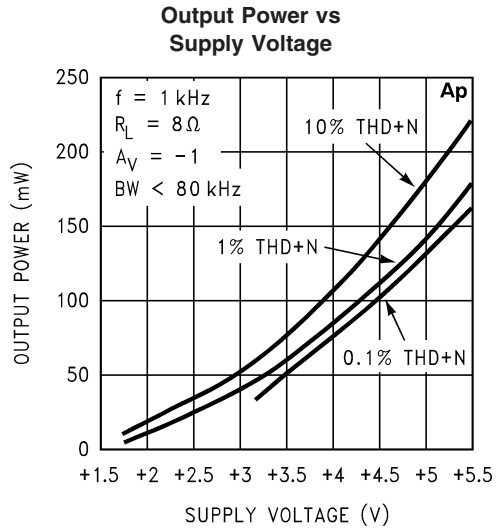
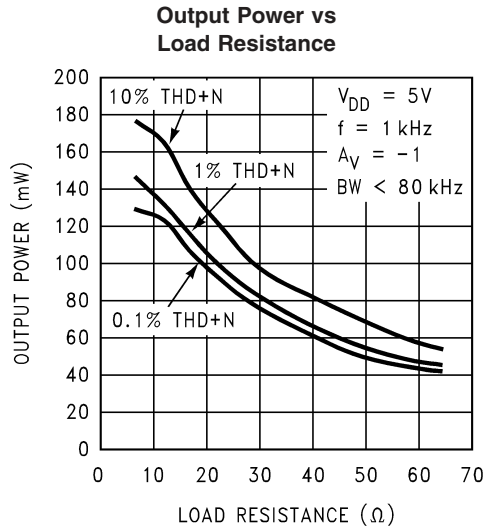

Typical Performance Characteristics (Continued)

Power Dissipation vs Output Power

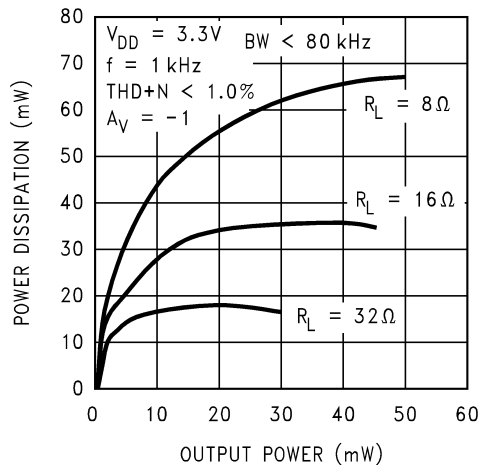

20006130

Power Dissipation vs Output Power

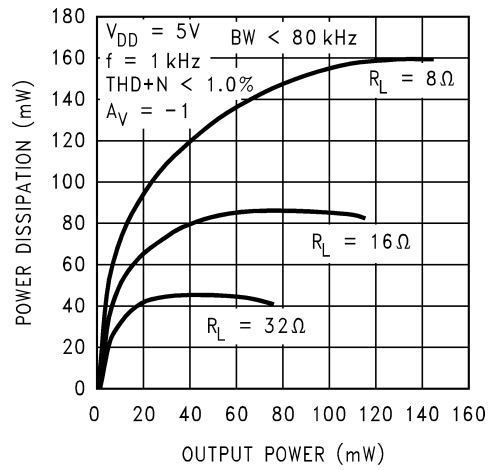

20006131

Channel Separation

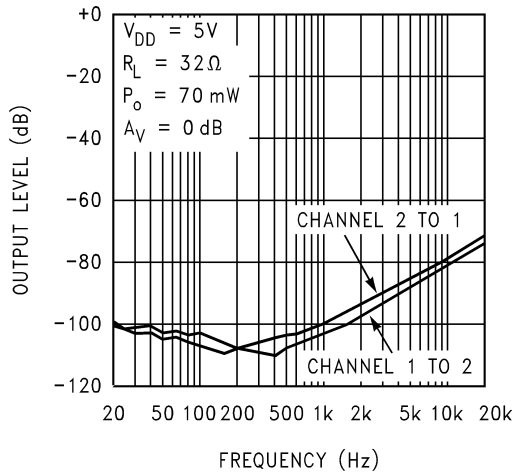

20006132

Channel Separation

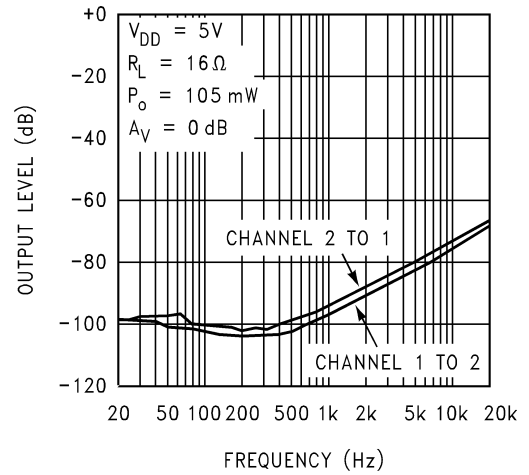

20006133

Noise Floor

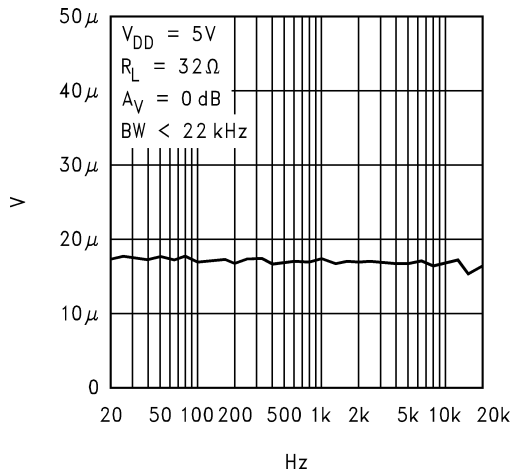

20006134

Power Supply Rejection Ratio

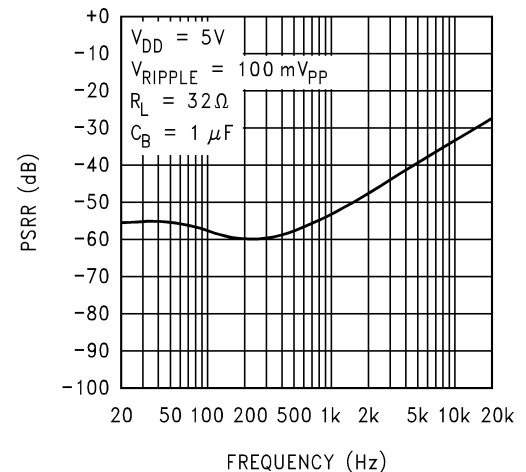

20006135

Typical Performance Characteristics (Continued)

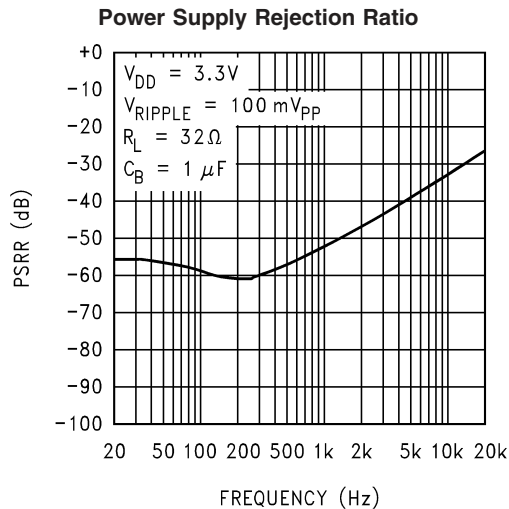

20006150

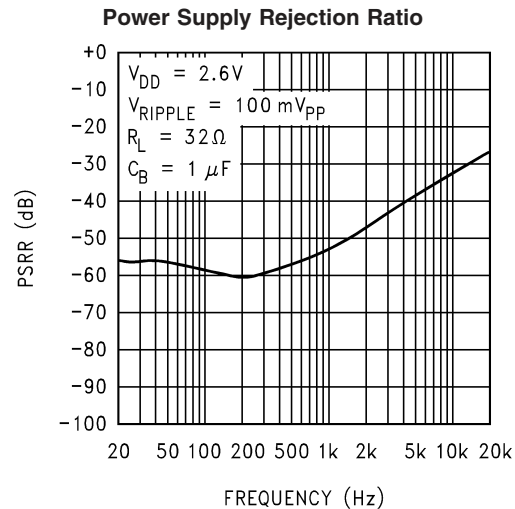

20006151

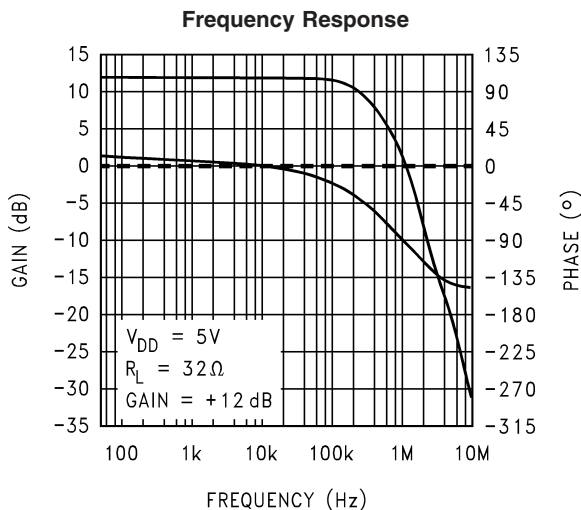

20006136

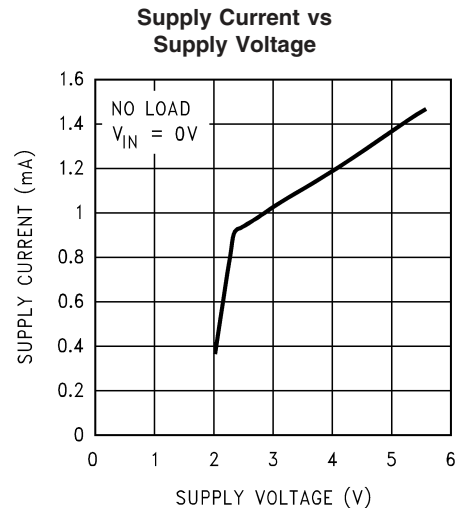

20006144

Application Information

DIGITAL VOLUME CONTROL

The LM4811's gain is controlled by the signals applied to the CLOCK and UP/DN inputs. An external clock is required to drive the CLOCK pin. At each rising edge of the clock signal, the gain will either increase or decrease by a 3dB step depending on the logic voltage level applied to the UP/DN pin. A logic high voltage level applied to the UP/DN pin causes the gain to increase by 3dB at each rising edge of the clock signal. Conversely, a logic low voltage level applied to the UP/DN pin causes the gain to decrease 3dB at each rising edge of the clock signal. For both the CLOCK and UP/DN inputs, the trigger point is 1.4V minimum for a logic high level, and 0.4V maximum for a logic low level.

There are 16 discrete gain settings ranging from +12dB maximum to -33dB minimum. Upon device power on, the amplifier's gain is set to a default value of 0dB. However, when coming out of shutdown mode, the LM4811 will revert back to its previous gain setting.

The LM4811's CLOCK and UP/DN pins should be de-bounced in order to avoid unwanted state changes during transitions between V_{IL} and V_{IH} . This will ensure correct operation of the digital volume control. A microcontroller or microprocessor output is recommended to drive the CLOCK and UP/DN pins.

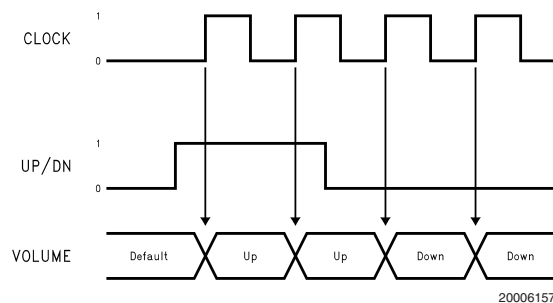

20006157

FIGURE 2. Timing Diagram

Application Information (Continued)

POWER DISSIPATION

Power dissipation is a major concern when using any power amplifier and must be thoroughly understood to ensure a successful design. Equation 1 states the maximum power dissipation point for a single-ended amplifier operating at a given supply voltage and driving a specified output load.

$$P_{DMAX} = (V_{DD})^2 / (2\pi^2 R_L) \quad (1)$$

Since the LM4811 has two operational amplifiers in one package, the maximum internal power dissipation point is twice that of the number which results from Equation 1. Even with the large internal power dissipation, the LM4811 does not require heat sinking over a large range of ambient temperature. From Equation 1, assuming a 5V power supply and a 32Ω load, the maximum power dissipation point is 40mW per amplifier. Thus the maximum package dissipation point is 80mW. The maximum power dissipation point obtained must not be greater than the power dissipation predicted by Equation 2:

$$P_{DMAX} = (T_{JMAX} - T_A) / \theta_{JA} \quad (2)$$

For the MSOP package, $\theta_{JA} = 194^\circ\text{C/W}$, and for the LD package, $\theta_{JA} = 63^\circ\text{C/W}$. $T_{JMAX} = 150^\circ\text{C}$ for the LM4811. For a given ambient temperature, T_A , of the system surroundings, Equation 2 can be used to find the maximum internal power dissipation supported by the IC packaging. If the result of Equation 1 is greater than that of Equation 2, then either the supply voltage must be decreased, the load impedance increased, or T_A reduced. For the MSOP package in a typical application of a 5V power supply and a 32Ω load, the maximum ambient temperature possible without violating the maximum junction temperature is approximately 134.5°C. This assumes the device operates at maximum power dissipation and uses surface mount packaging. Internal power dissipation is a function of output power. If typical operation is not around the maximum power dissipation point, operation at higher ambient temperatures is possible. Refer to the **Typical Performance Characteristics** curves for power dissipation information for lower output power levels.

EXPOSED-DAP PACKAGE PCB MOUNTING CONSIDERATION

The LM4811's exposed-dap (die attach paddle) package (LD) provides a low thermal resistance between the die and the PCB to which the part is mounted and soldered. This allows rapid heat transfer from the die to the surrounding PCB copper traces, ground plane, and surrounding air.

The LD package should have its DAP soldered to a copper pad on the PCB. The DAP's PCB copper pad may be connected to a large plane of continuous unbroken copper. This plane forms a thermal mass, heat sink, and radiation area.

However, since the LM4811 is designed for headphone applications, connecting a copper plane to the DAP's PCB copper pad is not required. The LM4811's Power Dissipation vs Output Power Curve in the **Typical Performance Characteristics** shows that the maximum power dissipated is just 45mW per amplifier with a 5V power supply and a 32Ω load.

Further detailed and specific information concerning PCB layout, fabrication, and mounting an LD (LLP) package is available from National Semiconductor's Package Engineering Group under application note AN1187.

POWER SUPPLY BYPASSING

As with any power amplifier, proper supply bypassing is critical for low noise performance and high power supply rejection. The capacitor location on both the bypass and power supply pins should be as close to the device as possible. The value of the bypass capacitor directly affects the LM4811's half-supply voltage stability and PSRR. The stability and supply rejection increase as the bypass capacitor's value increases. Typical applications employ a 5V regulator with 10μF and a 0.1μF bypass capacitors which aid in supply stability, but do not eliminate the need for bypassing the supply nodes of the LM4811. The selection of bypass capacitors, especially C_B , is thus dependent upon desired low frequency PSRR, click and pop performance, (explained in the section, **Proper Selection of External Components**), system cost, and size constraints.

SHUTDOWN FUNCTION

In order to reduce power consumption while not in use, the LM4811 features amplifier bias circuitry shutdown. This shutdown function is activated by applying a logic high to the SHUTDOWN pin. The trigger point is 1.4V minimum for a logic high level, and 0.4V maximum for a logic low level. It is best to switch between ground and V_{DD} to ensure optimal shutdown operation. By switching the SHUTDOWN pin to V_{DD} , the LM4811 supply current draw will be minimized in idle mode. Whereas the device will be disabled with shutdown voltages less than V_{DD} , the idle current may be greater than the typical value of 0.3μA. In either case, the SHUTDOWN pin should be tied to a fixed voltage to avoid unwanted state changes.

In many applications, a microcontroller or microprocessor output is used to control the shutdown circuitry. This provides a quick, smooth shutdown transition. Another solution is to use a single-pole, single-throw switch in conjunction with an external pull-up resistor. When the switch is closed, the SHUTDOWN pin is connected to ground and enables the amplifier. If the switch is open, the external pull-up resistor, R_{PU} , will disable the LM4811. This scheme guarantees that the SHUTDOWN pin will not float, thus preventing unwanted state changes.

PROPER SELECTION OF EXTERNAL COMPONENTS

Selection of external components when using integrated power amplifiers is critical for optimum device and system performance. While the LM4811 is tolerant of external component combinations, consideration must be given to the external component values that maximize overall system quality.

The LM4811's unity-gain stability allows a designer to maximize system performance. Low gain settings maximize signal-to-noise performance and minimizes THD+N. Low gain configurations require large input signals to obtain a given output power. Input signals equal to or greater than 1 Vrms are available from sources such as audio codecs. Please refer to the section, **Audio Power Amplifier Design**, for a more complete explanation of proper gain selection.

Application Information (Continued)

Selection of Input and Output Capacitor Size

Besides gain, one of the major considerations is the closed loop bandwidth of the amplifier. To a large extent, the bandwidth is dictated by the choice of external components shown in *Figure 1*. Both the input coupling capacitor, C_i , and the output coupling capacitor, C_o , form first order high pass filters which limit low frequency response. These values should be based on the desired frequency response weighed against the following:

Large value input and output capacitors are both expensive and space consuming for portable designs. Clearly a certain sized capacitor is needed to couple in low frequencies without severe attenuation. But in many cases the speakers used in portable systems, whether internal or external, have little ability to reproduce signals below 150Hz. Thus large input and output capacitors may not increase system performance.

In addition to system cost and size, click and pop performance is affected by the size of the input coupling capacitor, C_i . A larger input coupling capacitor requires more charge to reach its quiescent DC voltage (nominally $1/2 V_{DD}$). This charge comes from the output via the feedback and is apt to create pops upon device enable. Turn on pops can be minimized by reducing C_i value based on necessary low frequency response.

Besides minimizing the input and output capacitor values, careful consideration should be paid to the bypass capacitor value. Bypass capacitor C_B is the most critical component to minimize turn on pops since it determines how fast the LM4811 turns on. The slower the LM4811's outputs ramp to their quiescent DC voltage (nominally $1/2 V_{DD}$), the smaller the turn on pop. While the device will function properly, (no oscillations or motorboating), with C_B equal to $1\mu\text{F}$, the device will be much more susceptible to turn on clicks and pops. Thus, a value of C_B equal to $1\mu\text{F}$ or larger is recommended in all but the most cost sensitive designs.

Also, careful consideration must be taken in selecting a certain type of capacitor to be used in the system. Different types of capacitors (tantalum, electrolytic, ceramic) have unique performance characteristics and may affect overall system performance.

AUDIO POWER AMPLIFIER DESIGN

Design a Dual 70mW/32Ω Audio Amplifier

Given:

Power Output	70mW
Load Impedance	32Ω
Input Level	1Vrms (max)
Input Impedance	33kΩ (min)
Bandwidth	100 Hz–20 kHz ± 0.50dB

A designer must first determine the minimum supply rail to obtain the specified output power. By extrapolating from the

Output Power vs Supply Voltage graphs in the **Typical Performance Characteristics** section, the supply rail can be easily found. A second way to determine the minimum supply rail is to calculate the required V_{OPEAK} using Equation (3) and add the dropout voltage. For a single-ended application, the minimum supply voltage can be approximated by $(2V_{OPEAK} + (V_{ODTOP} + V_{ODBOT}))$, where V_{ODBOT} and V_{ODTOP} are extrapolated from the Dropout Voltage vs Supply Voltage curve in the **Typical Performance Characteristics** section.

$$V_{opeak} = \sqrt{(2R_L P_O)} \quad (3)$$

Using the Output Power vs Supply Voltage graph for a 32Ω load, the minimum supply rail is 4.8V. Since 5V is a standard supply voltage in most applications, it is chosen for the supply rail. Extra supply voltage creates headroom that allows the LM4811 to reproduce peaks in excess of 70mW without clipping the signal. At this time, the designer must make sure that the power supply choice along with the output impedance does not violate the conditions explained in the **Power Dissipation** section. Remember that the maximum power dissipation point from Equation 1 must be multiplied by two since there are two independent amplifiers inside the package.

The final design step is to address the bandwidth requirements which must be stated as a pair of -3dB frequency points. Five times away from a -3dB point is 0.17dB down from passband response assuming a single pole roll-off. As stated in the **External Components** section, C_i and C_o create first order highpass filters. Thus to obtain the desired frequency low response of 100Hz within $\pm 0.5\text{dB}$, both poles must be taken into consideration. The combination of two single order filters at the same frequency forms a second order response. This results in a signal which is down 0.34dB at five times away from the single order filter -3dB point. Thus, a frequency of 20Hz is used in the following equations to ensure that the response is better than 0.5dB down at 100Hz.

$$C_i \geq 1 / (2\pi * 33 \text{ k}\Omega * 20 \text{ Hz}) = 0.241\mu\text{F}; \text{ use } 0.39\mu\text{F} \quad (4)$$

$$C_o \geq 1 / (2\pi * 32\Omega * 20 \text{ Hz}) = 249\mu\text{F}; \text{ use } 330\mu\text{F} \quad (5)$$

The high frequency pole is determined by the product of the desired high frequency pole, f_H , and the closed-loop gain, A_V . With a closed-loop gain of 3.98 or +12dB and $f_H = 100\text{kHz}$, the resulting GBWP = 398kHz which is much smaller than the LM4811 GBWP of 1MHz. This figure displays that at the maximum gain setting of 3.98 or +12dB, the LM4811 can be used without running into bandwidth limitations.

Application Information (Continued)

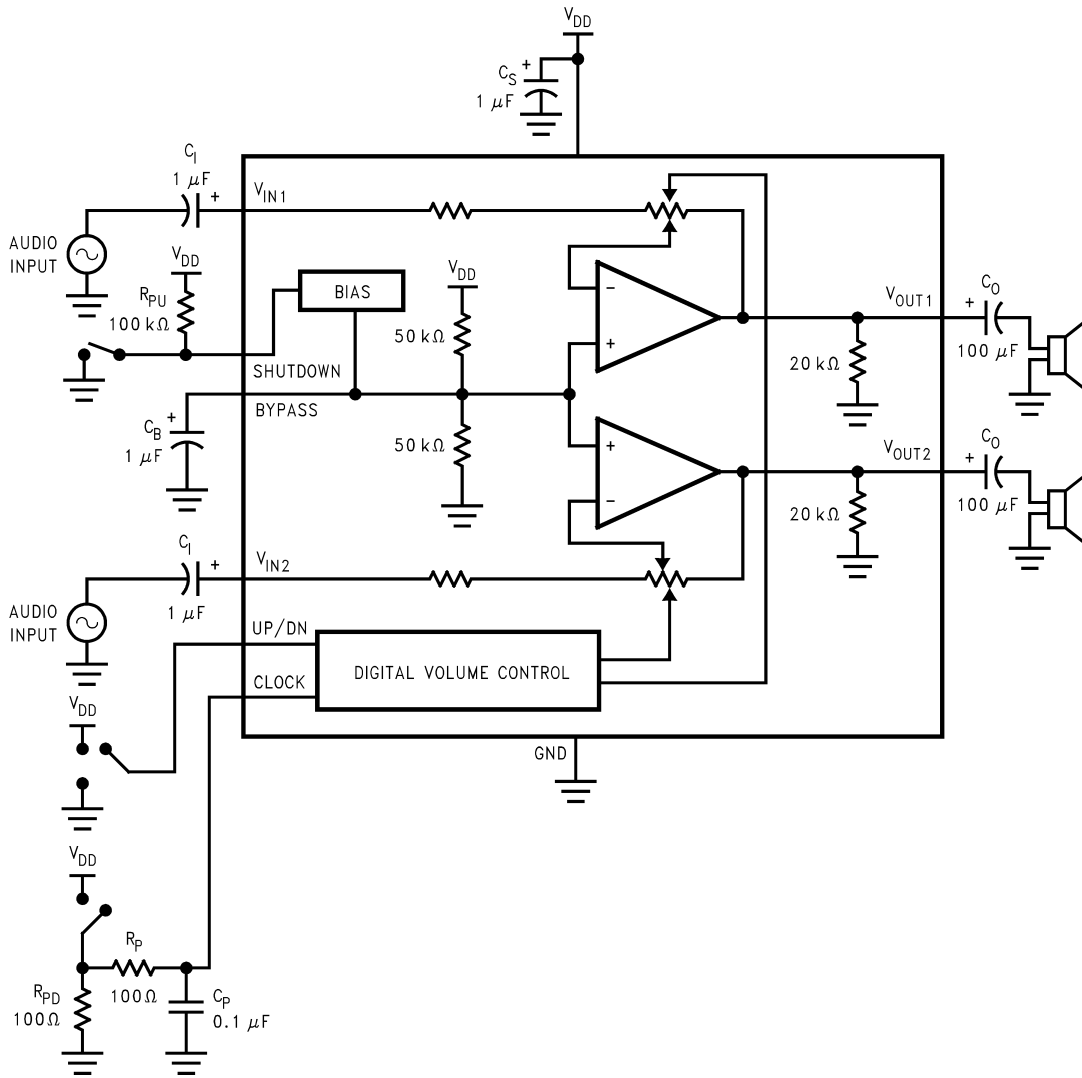

20006161

FIGURE 3. Demo Board Schematic

Application Information (Continued)

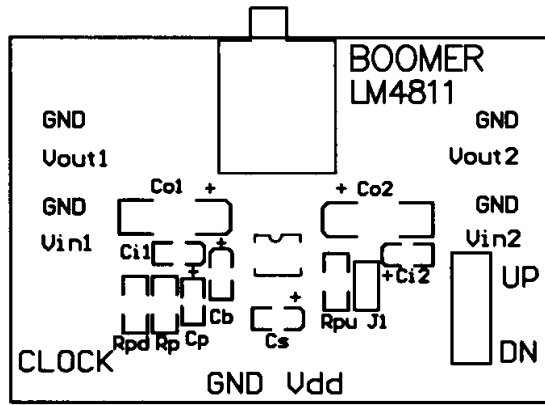

20006158

FIGURE 4. Recommended MSOP PC Board Layout:
TOP Silk Screen

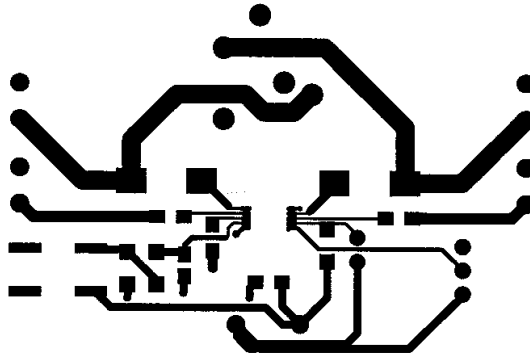

20006159

FIGURE 5. Recommended MSOP PC Board Layout:
TOP Top Layer

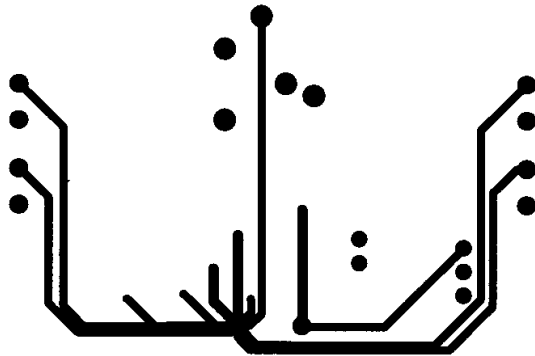

20006160

FIGURE 6. Recommended MSOP PC Board Layout:
Bottom Layer

Application Information (Continued)

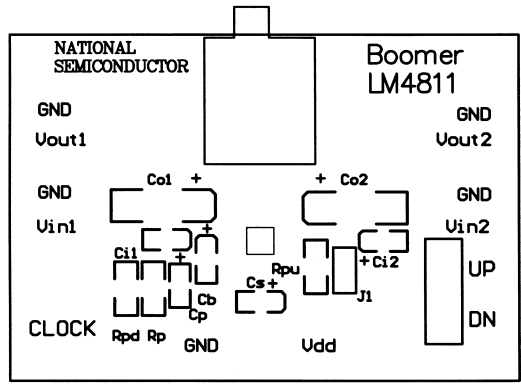

20006163

FIGURE 7. Recommended LD PC Board Layout: TOP Silk Screen

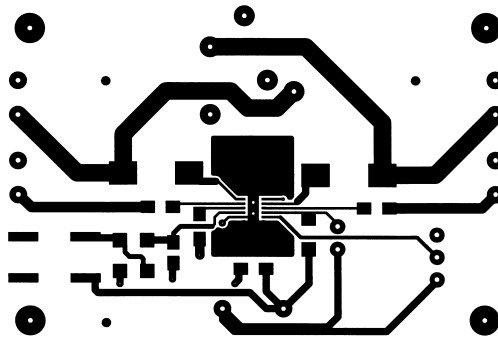

20006164

FIGURE 8. Recommended LD PC Board Layout: TOP Top Layer

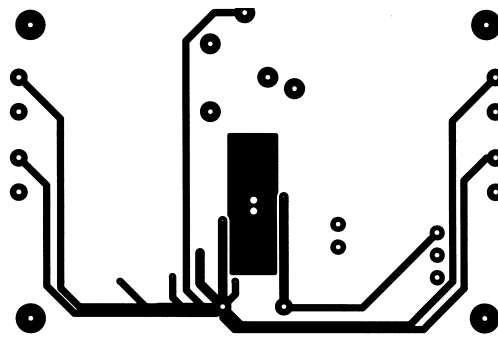

20006165

FIGURE 9. Recommended LD PC Board Layout: Bottom Layer

Physical Dimensions inches (millimeters) unless otherwise noted

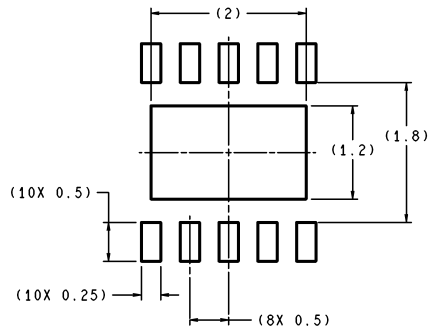

RECOMMENDED LAND PATTERN
1:1 RATION WITH PKG SOLDER PADS

DIMENSIONS ARE IN MILLIMETERS

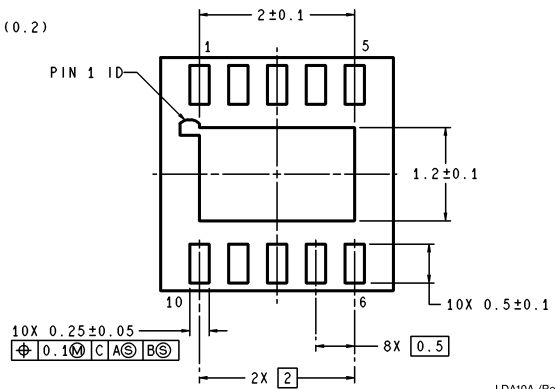
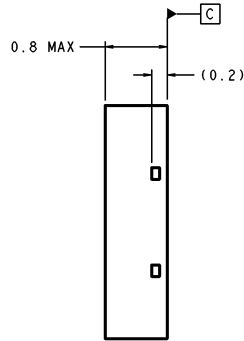
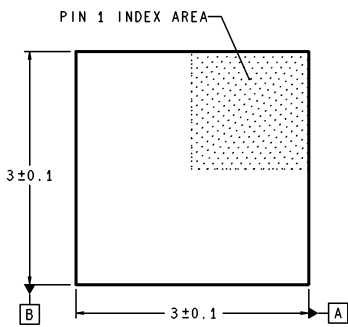

LDA10A (Rev A)

Order Number LM4811LD
NS Package Number LDA10A

Physical Dimensions inches (millimeters) unless otherwise noted (Continued)

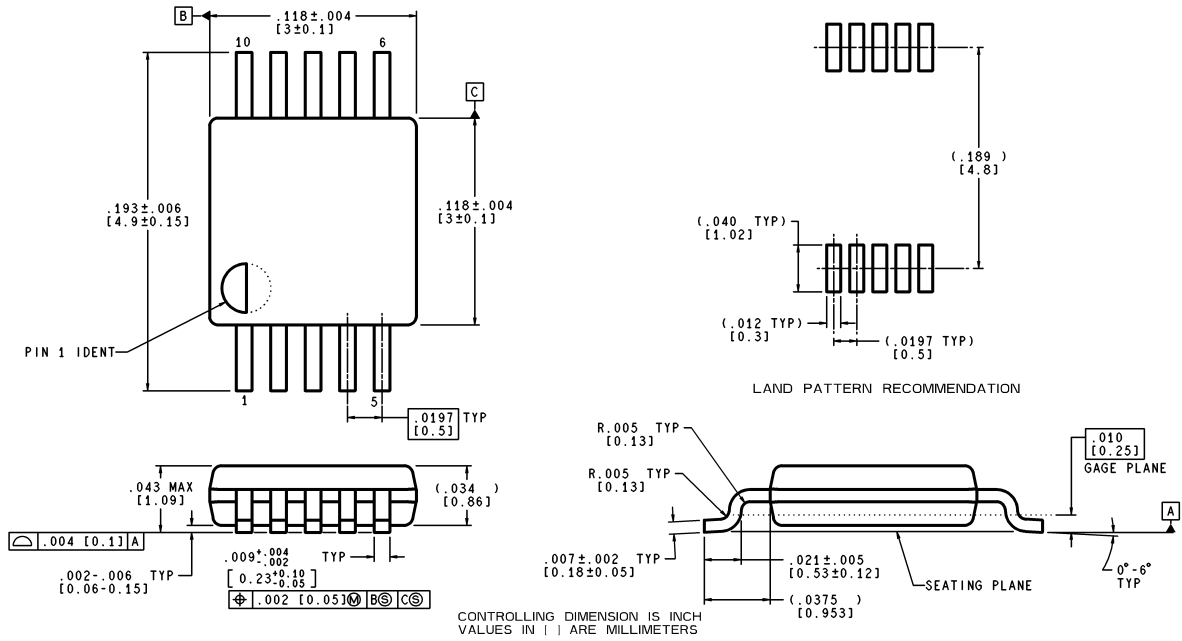

MUB10A (Rev A)

Order Number LM4811MM
NS Package Number MUB10A

LIFE SUPPORT POLICY

NATIONAL'S PRODUCTS ARE NOT AUTHORIZED FOR USE AS CRITICAL COMPONENTS IN LIFE SUPPORT DEVICES OR SYSTEMS WITHOUT THE EXPRESS WRITTEN APPROVAL OF THE PRESIDENT AND GENERAL COUNSEL OF NATIONAL SEMICONDUCTOR CORPORATION. As used herein:

1. Life support devices or systems are devices or systems which, (a) are intended for surgical implant into the body, or (b) support or sustain life, and whose failure to perform when properly used in accordance with instructions for use provided in the labeling, can be reasonably expected to result in a significant injury to the user.
2. A critical component is any component of a life support device or system whose failure to perform can be reasonably expected to cause the failure of the life support device or system, or to affect its safety or effectiveness.

 **National Semiconductor Corporation**
 Americas
 Email: support@nsc.com

www.national.com

National Semiconductor Europe
 Fax: +49 (0) 180-530 85 86
 Email: europe.support@nsc.com
 Deutsch Tel: +49 (0) 69 9508 6208
 English Tel: +44 (0) 870 24 0 2171
 Français Tel: +33 (0) 1 41 91 8790

National Semiconductor Asia Pacific Customer Response Group
 Tel: 65-2544466
 Fax: 65-2504466
 Email: ap.support@nsc.com

National Semiconductor Japan Ltd.
 Tel: 81-3-5639-7560
 Fax: 81-3-5639-7507